

VÁLIDA HASTA EL 31 DE DIC. 2023



05

hall

C66

stand

[www.gerardi.it](http://www.gerardi.it)

# OFERTA ESPECIAL

EMO 2023

**CABEZALES ANGULARES**  
Línea clásica

**HERRAMIENTAS  
MOTORIZADAS**  
Para tornos & Torretas

PRONTO ESTARÁ DISPONIBLE EL NUEVO

**ESCARIADOR MODULAR** HTAS. MOTORIZADAS

**Mejora tu Torno CNC**

Crea ranuras y cavidades internas directamente en el torno.



Acceso al folleto

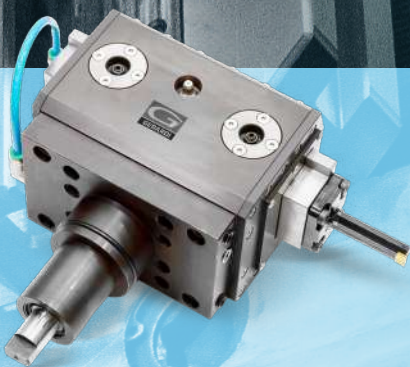



Válido hasta el 31 de Diciembre 2023

## MORDAZAS AUTOCENTRANTES CON BOCAS REVERSIBLES - PERFECTAS PARA CENTROS DE MECANIZADO DE 5 EJES

Art.650



Equipamiento estándar: 1 llave de vaso, 1 Centrado calibrado, 2 posicionamiento de las tuercas y 2 tuercas autocentrantes

**+** Tope magnético Art. 370EM

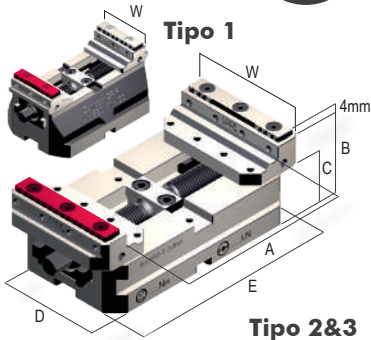

Tipo 2&3

Tipo	1 - 12kN			2 - 22kN				3 - 32kN				
Anchura de la boca W	50			88				123				
Max. apertura A	54	94	134	96	136	176	216	133	183	233	283	333
Altura de la mordaza B	65			65				89				
Altura de la base C	45			38				57				
Anchura de la base D	79,9			89,9				124,9				
Anchura de la base E	80	120	160	120	160	200	240	160	210	260	310	360
Kg	1,9	2,7	3,4	3,6	4,4	5,2	5,8	9,1	10,9	12,8	14,8	17
REF.	7.65.01080	7.65.01120	7.65.01160	7.65.02120	7.65.02160	7.65.02200	7.65.02240	7.65.03160	7.65.03210	7.65.03260	7.65.03310	7.65.03360
PRECIO €	<del>754</del>	<del>870</del>	<del>985</del>	<del>927</del>	<del>1.043</del>	<del>1.159</del>	<del>1.275</del>	<del>1.506</del>	<del>1.737</del>	<del>1.969</del>	<del>2.317</del>	<del>2.548</del>
PRECIO ESPECIAL €	649	749	849	749	849	949	1.049	1.249	1.349	1.449	1.749	1.949

## PLAQUITAS DE SUJECIÓN ADECUADAS PARA CUALQUIER TIPO DE DUREZA Y MATERIAL

Art.650S	Art.650T G01	Art.650T G02	Art.650T G11	Art.650R	Art.650X
7.65.0S	7.65.0T	7.65.0T	7.65.0T	7.65.0R	7.65.0X
1000 2000 3000	1000/G01 2000/G01 3000/G01	1000/G02 2000/G02 3000/G02	1000/G11 2000/G11 3000/G11	1000 2000 3000	1000 2000 3000
<del>€78</del> <del>€78</del> <del>€78</del>	<del>€39</del> <del>€50</del> <del>€78</del>	<del>€39</del> <del>€50</del> <del>€78</del>	<del>€39</del> <del>€50</del> <del>€78</del>	<del>€34</del> <del>€34</del> <del>€34</del>	<del>€166</del> <del>€193</del> <del>€214</del>
€58 €58 €58	€29 €37 €58	€29 €37 €58	€29 €37 €58	€25 €25 €25	€122 €142 €158

## ELEVADORES PARA MORDAZAS COMPACT GRIP

Art.651H

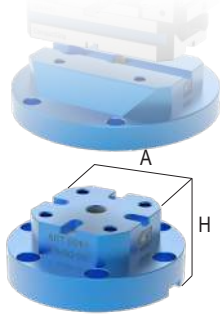

H	Tipo	1			2				3				
	Min A	80	120	160	120	160	200	240	160	210	260	310	360
50	Ref.	7.65.1H1080 /050	7.65.1H1120 /050	7.65.1H1160 /050	7.65.1H2120 /050	7.65.1H2160 /050	7.65.1H2200 /050	7.65.1H2240 /050	7.65.1H3160 /050	7.65.1H3210 /050	7.65.1H3260 /050	7.65.1H3310 /050	7.65.1H3360 /050
	PRECIO €	<del>401</del>	<del>477</del>	<del>570</del>	<del>570</del>	<del>570</del>	<del>570</del>	<del>705</del>	<del>660</del>	<del>660</del>	<del>1.016</del>	<del>1.053</del>	<del>1.218</del>
	PRECIO ESPECIAL €	350	400	450	450	500	550	600	650	650	950	1.000	1.100
75	Ref.	7.65.1H1080 /075	7.65.1H1120 /075	7.65.1H1160 /075	7.65.1H2120 /075	7.65.1H2160 /075	7.65.1H2200 /075	7.65.1H2240 /075	7.65.1H3160 /075	7.65.1H3210 /075	7.65.1H3260 /075	7.65.1H3310 /075	7.65.1H3360 /075
	PRECIO €	<del>412</del>	<del>501</del>	<del>601</del>	<del>601</del>	<del>601</del>	<del>601</del>	<del>750</del>	<del>704</del>	<del>704</del>	<del>1.073</del>	<del>1.112</del>	<del>1.287</del>
	PRECIO ESPECIAL €	350	400	500	500	550	600	600	650	700	950	1.000	1.100
100	Ref.	7.65.1H1080 /100	7.65.1H1120 /100	7.65.1H1160 /100	7.65.1H2120 /100	7.65.1H2160 /100	7.65.1H2200 /100	7.65.1H2240 /100	7.65.1H3160 /100	7.65.1H3210 /100	7.65.1H3260 /100	7.65.1H3310 /100	7.65.1H3360 /100
	PRECIO €	<del>424</del>	<del>523</del>	<del>634</del>	<del>634</del>	<del>634</del>	<del>634</del>	<del>796</del>	<del>746</del>	<del>746</del>	<del>1.133</del>	<del>1.171</del>	<del>1.357</del>
	PRECIO ESPECIAL €	350	400	500	500	550	600	650	650	700	950	1.000	1.100

## SOPORTE PIRAMIDAL PARA CENTROS DE 5 EJES - INCLUYE MORDAZA MONTADA Y ALINEADA

Equipamiento estándar: 12 Mordazas de sujeción Art.298 CGR, 1 cáncamo, 1 Pasador de centrado, Par de tuercas Art.297

MONTAJE Y ALINEAMIENTO INCLUIDOS

Art.643H

Art.660 Mesas de cambio rápido

Soprote piramidal de aluminio, permite el montaje simultáneo de 3 mordazas CompactGrip (con o sin mesas de cambio rápido) inclinadas a 45° o 60° aumentando así el espacio de trabajo y permitiendo el mecanizado de múltiples piezas incluso en puntos de difícil acceso.

**KIT 2**

Art.650 T.1x120

60°

Tipo	1 (ø200)
Altura	170
Ref.	7.64.3H100
PRECIO €	<del>4.373</del>
PRECIO ESPECIAL €	3.400

**KIT 2**

Art.650 T.2x200

30° 45°

Tipo	2 (ø308)
Altura	136
Ref.	7.64.3H200
PRECIO €	<del>5.571</del>
PRECIO ESPECIAL €	4.200

**KIT 3**

Nº3 Art.650 T.3x210

30° 45°

Tipo	3 (ø360)
Altura	190
Ref.	7.64.3H300
PRECIO €	<del>7.525</del>
PRECIO ESPECIAL €	5.300

\* Comprobar el giro del eje de la máquina

\* Comprobar el giro del eje de la máquina



Válido hasta el 31 de Diciembre 2023

## MESAS DE CAMBIO RÁPIDO PARA MORDAZAS COMPACTGRIP - PERFECTAS PARA MÁQUINAS DE 5 EJES

### Art.660

Mesa mecánica rectangular de cambio rápido

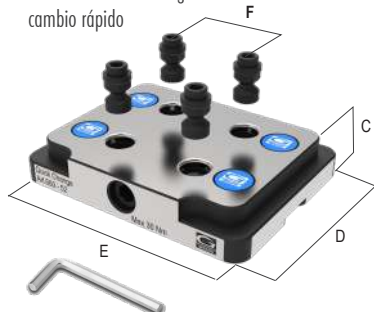

Equipamiento estándar: 4 Pernos Art.660B

Tipo	1- 2	3
F	52	96
C	27	27
D	116	156
E	150	190
kg	3	5,2
Ref.	9.66.05200	9.66.09600
PRECIO €	<del>764</del>	<del>1.100</del>
PRECIO ESPECIAL €	649	949

### Art.661

Mesa mecánica redonda de cambio rápido



Equipamiento estándar: 4 Pernos Art.660B

Tipo	1- 2	3
F	52	96
ØA	156	196
ØB	120	175
C	27	27
kg	3	5,2
Ref.	9.66.15200	9.66.19600
PRECIO €	<del>732</del>	<del>1.069</del>
PRECIO ESPECIAL €	649	949

### Art.660S

Mesa rectangular endurecida de cambio rápido con agujeros mecanizables



Equipamiento estándar: 4 Pernos Art.660B

Tipo	1- 2	3
F	52	96
C	27	27
D	126	156
E	150	190
kg	3	5,2
Ref.	9.66.05520	9.66.05960
PRECIO €	<del>619</del>	<del>844</del>
PRECIO ESPECIAL €	549	749
Personalización excluida		

### Art.661S

Mesa redonda endurecida de cambio rápido con agujeros mecanizables

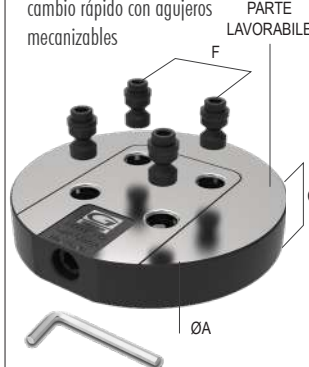

Disponibles Mesas de Cambio Rápido para cualquier tipo de Mesas Giratorias o 4º Eje

Equipamiento estándar: 4 Pernos Art.660B

Tipo	1- 2	3		
F	52	96		
ØA	156	196	250	300
C	27	27	24	24
kg	3,8	6	10	15
Ref.	9.66.15200	9.66.19600	9.66.15960-250	9.66.15960-310
PRECIO €	<del>675</del>	<del>1.125</del>	<del>1.599</del>	<del>1.699</del>
PRECIO ESPECIAL €	549	749	1.550	1.650
Personalización excluida				

### Art.660R

Mesa reductora rectangular mecánica de cambio rápido

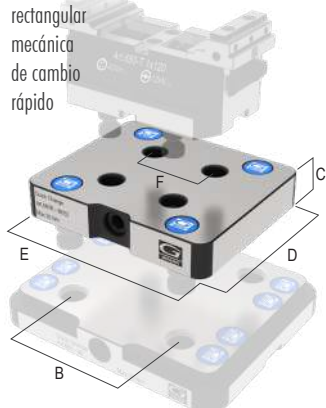

Equipamiento estándar: 4 Pernos Art.660B

F	52
B	96
C	27
D	126
E	150
kg	3,75
Ref.	9.66.0R210
PRECIO €	<del>675</del>
PRECIO ESPECIAL €	549

### Art.661R

Mesa redonda de reducción

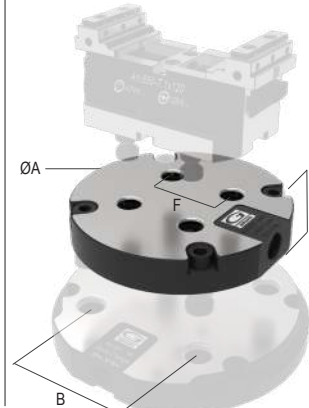

Equipamiento estándar: 4 Pernos Art.660B

F	52
A	158
B	96
C	27
kg	3,75
Ref.	9.66.1R210
PRECIO €	<del>844</del>
PRECIO ESPECIAL €	549

### Art.660B

Pernos de mesa de cambio rápido



Tipo	1	2
Ref.	9.66.0B100	9.66.0B200
PRECIO €	30	32

### Art.661H

Placa base de aluminio para mesa de cambio rápido, puede montarse con soportes o mediante Punto cero.



### Art.661S

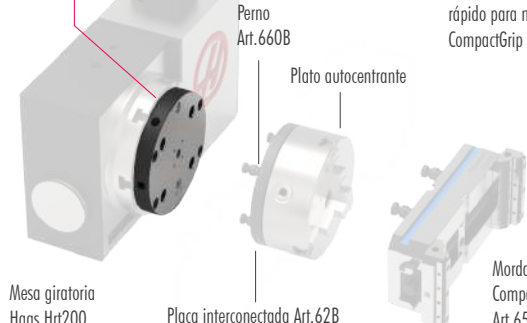

EJEMPLO Montaje de una mesa redonda de cambio rápido para mordazas CompactGrip

Mordazas CompactGrip Art.650 T.3

# MORDAZAS STANDARD FLEX

Válido hasta el 31 de Diciembre 2023

5 AÑOS DE GARANTÍA

DESCUENTO HASTA EL **24%**



INNOVADOR SISTEMA PARA CAMBIO RÁPIDO DE PLACAS DE MORDAZAS - PERFECTO PARA CENTROS DE MECANIZADO VERTICALES

## Art.1A

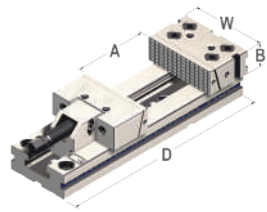

Mordaza modular de precisión serie StandardFLEX

Equipamiento estándar: 1 tope, 2 tuercas de posicionamiento para ranuras de 16 mm, 2 placas Art. 291, 1 llave de tubo, 1 llave en "T" + 4 Pinzas de sujeción Art.298



Tipo	2 - 25kN	3 - 30kN			4 - 30kN		5 - 40kN		
Max apertura A	150	200	300	200	300	400	200	300	400
Anchura de la boca W	121 mm	146 mm			171 mm		196 mm		
Altura de la boca B	38	48			58		63		
Longitud de la base D	345	420	520	455	555	655	495	595	695
Ref.	1.1A.20000	1.1A.32000	1.1A.33000	1.1A.42000	1.1A.43000	1.1A.44000	1.1A.52000	1.1A.53000	1.1A.54000
PRECIO €	<del>898</del>	<del>1.079</del>	<del>1.245</del>	<del>1.372</del>	<del>1.509</del>	<del>1.646</del>	<del>1.792</del>	<del>2.145</del>	<del>2.506</del>
PRECIO ESPECIAL €	789	839	949	1.189	1.239	1.339	1.489	1.789	2.039

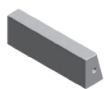

\* Art.230B Lisa



\* Art.230C Pulida



\* Art.230E Con paso



\* Art.230F Prismática



\* Art.138 Cuadrada tipo pila



\* Art.150 Prismática tipo pila



\* Art.212 Móvil intermedia con doble paso



\* Art.257 Dispositivo de sujeción de tornillo manual hidráulico



Art.297 Tuercas de posicionamiento  $\neq 16$

DESCUENTO HASTA EL **22%**

\* Comprando una mordaza completa

# MORDAZAS EXTRA LARGAS

5 AÑOS DE GARANTÍA

DESCUENTO HASTA EL **28%**



MORDAZA CON BASE EXTRA GRANDE, MUCHO MÁS LARGA QUE LAS MORDAZAS ESTÁNDAR - PERFECTAS PARA CENTROS DE MECANIZADO VERTICALES

## Art.21

(Sujeción única)

Equipamiento estándar: 1 tope, 2 tuercas de posicionamiento para ranuras de 16 mm, 2 placas Art. 291, 1 llave de tubo, 1 llave en "T" + 4 Pinzas de sujeción Art.298

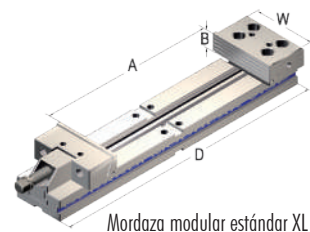

Mordaza modular estándar XL

Tipo	2 - 25kN	3 - 30kN		4 - 30kN		
Max apertura A	320	360	460	500	600	700
Anchura de la boca W	125 mm	150 mm		175mm		
Altura de la boca B	40	50		60		
Longitud de la base D	520	580	680	766	866	966
Ref.	2.21.23200	2.21.33600	2.21.34600	2.21.45000	2.21.46000	2.21.47000
kg	17	32	35	52	56	61
PRECIO €	<del>1.113</del>	<del>1.383</del>	<del>1.532</del>	<del>1.774</del>	<del>1.932</del>	<del>2.096</del>
PRECIO ESPECIAL €	800	1.000	1.150	1.350	1.450	1.550

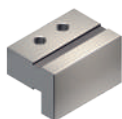

\* Art.138 Cuadrada tipo pila



\* Art.150 Prismática tipo pila



\* Art.217 Prismática móvil



\* Art.313 Placas magnéticas paralelas

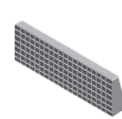

\* Art.2305 Placa dentada



Art.297 Tuercas de posicionamiento  $\neq 16$

DESCUENTO HASTA EL **22%**

\* Comprando una mordaza completa

# PLATOS MAGNETICOS PARALELOS

WOOW

## Art.414

También Disponibles Placas Magnéticas Paralelas Universales

DESCUENTO HASTA EL **48%**



AMPLIA GAMA DE ALTURAS DISPONIBLES EN LA PÁGINA 4.27 - PRECIO W16

### Dimensiones - Tipo

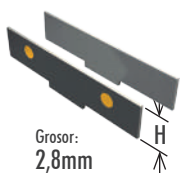

Grosor: 2,8mm

## Art.310

6 PARES

6 pares de barras paralelas (Art.313-313R)  
Precio de cada uno en caso de compra fija

PRECIO € ~~276~~ ~~348~~ ~~420~~ ~~498~~ ~~552~~ ~~636~~  
PRECIO ESPECIAL € 46 58 70 83 92 106

## Art.311

10 PARES

10 pares de barras paralelas (Art.313-313R)  
Precio de cada uno en caso de compra fija

PRECIO € - - ~~600~~ ~~710~~ ~~780~~ ~~920~~  
PRECIO ESPECIAL € - - 60 71 78 92



TODOS LOS COMPONENTES ESTÁN CONSTRUIDOS ÍNTEGRAMENTE CON ACERO DE ALTA RESISTENCIA Y CEMENTADOS



Válido hasta el 31 de Diciembre 2023

## UNIDAD CON MANDO NEUMÁTICO Y CILINDRO SIMPLE - PERFECTO PARA CENTROS DE MECANIZADO VERTICALES

PARA MORDAZAS STANDARD & STANDARDFLEX ART. 1 e A R T.1A

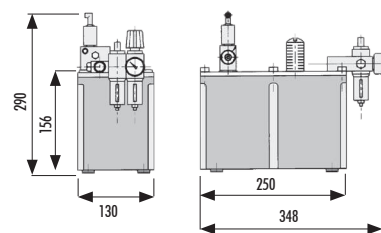
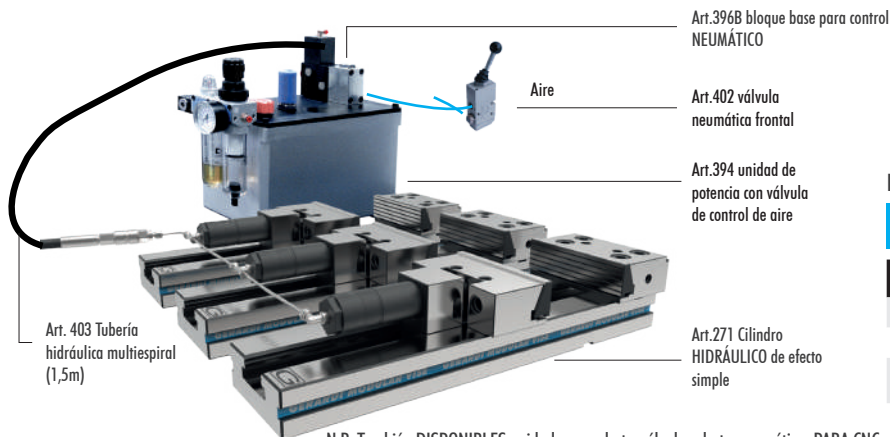

Nº1 SUJECCIÓN

### Art.392

MORDAZA NO INCLUIDA

Tipo	2	3	4	5
Trazado Art.271	26		40	
Ref.	4.39.22000	4.39.23000	4.39.24000	4.39.25000
PRECIO €	<del>1.817</del>	<del>1.829</del>	<del>1.861</del>	<del>2.046</del>
PRECIO ESPECIAL €	1.499	1.499	1.499	1.599

N.B. También DISPONIBLES unidades con electroválvulas electromagnéticas PARA CNC

## KITS DE MORDAZAS DE SUJECCIÓN SIMULTÁNEA

\*Art.405H Tubo de acero galvanizado compatible Ø6 (m1,0)  
(No incluido) Ref.: 4.40.5H000

### Art.392/2

(Art.271- 394 - 402 - 403)

Nº2 SUJECCIÓN SIMULTÁNEA  
Art.392 + Nº1 Art.271

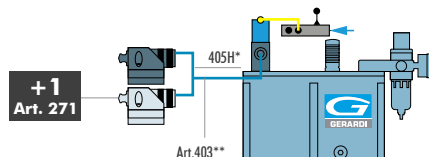

Tipo	2	3	4	5
Ref.	4.39.22002	4.39.23002	4.39.24002	4.39.25002
PRECIO €	<del>2.187</del>	<del>2.210</del>	<del>2.276</del>	<del>2.645</del>
PRECIO ESPECIAL €	1.799	1.799	1.799	2.099

### Art.392/3

Nº3 SUJECCIÓN SIMULTÁNEA  
Art.392 + Nº2 Art.271

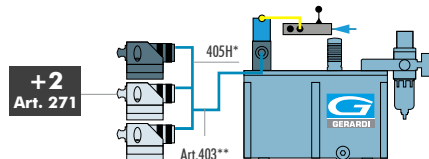

Tipo	2	3	4	5
Ref.	4.39.22003	4.39.23003	4.39.24003	4.39.25003
PRECIO €	<del>2.557</del>	<del>2.589</del>	<del>2.686</del>	<del>3.243</del>
PRECIO ESPECIAL €	2.099	2.099	2.099	2.499

### Art.392/4

Nº4 SUJECCIÓN SIMULTÁNEA  
Art.392 + Nº3 Art.271

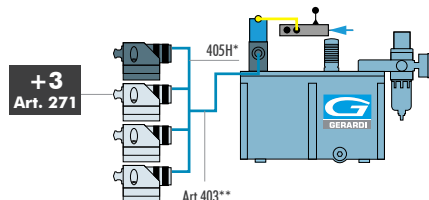

Tipo	2	3	4	5
Ref.	4.39.22004	4.39.23004	4.39.24004	4.39.25004
PRECIO €	<del>2.929</del>	<del>2.969</del>	<del>3.102</del>	<del>3.842</del>
PRECIO ESPECIAL €	2.399	2.399	2.399	2.999

## KITS DE GRUPOS DE SUJECCIÓN INDEPENDIENTE

\*Art.403 (Incluido) Tubo hidráulico Multiespiral completo 760bar con conexión rápida Art. 270A (m 1,5) Ref.: 4.40.30000

### Art.392A/2

(Art.271- 394 - 402 - 403)

Nº2 SUJECCIÓN SIMULTÁNEA  
Art.392 + Nº1 Art.407B

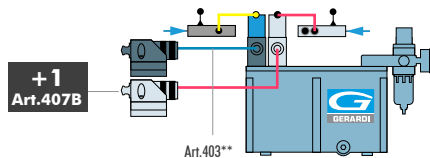

Tipo	2	3	4	5
Ref.	4.39.2A202	4.39.2A302	4.39.2A402	4.39.2A502
PRECIO €	<del>2.973</del>	<del>2.993</del>	<del>3.068</del>	<del>3.533</del>
PRECIO ESPECIAL €	2.399	2.399	2.399	2.799

### Art.392A/3

Nº3 SUJECCIÓN SIMULTÁNEA  
Art.392 + Nº2 Art.407B

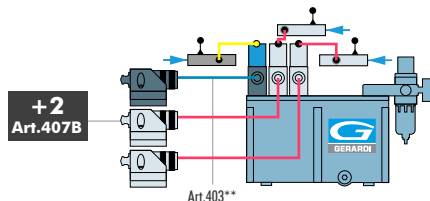

Tipo	2	3	4	5
Ref.	4.39.2A203	4.39.2A303	4.39.2A403	4.39.2A503
PRECIO €	<del>3.460</del>	<del>3.491</del>	<del>3.587</del>	<del>4.123</del>
PRECIO ESPECIAL €	2.799	2.799	2.799	3.299

### Art.392A/4

Nº4 SUJECCIÓN SIMULTÁNEA  
Art.392 + Nº3 Art.407B

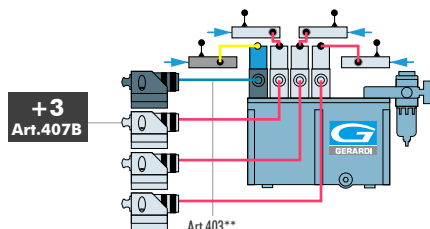

Tipo	2	3	4	5
Ref.	4.39.2A204	4.39.2A304	4.39.2A404	4.39.2A504
PRECIO €	<del>4.284</del>	<del>4.325</del>	<del>4.450</del>	<del>5.164</del>
PRECIO ESPECIAL €	3.599	3.599	3.599	4.199

Válido hasta el 31 de Diciembre 2023

### PARA SUJECIÓN ÚNICA, DOBLE Y AUTOCENTRANTE - PERFECTAS PARA MECANIZADO VERTICAL Y HORIZONTAL

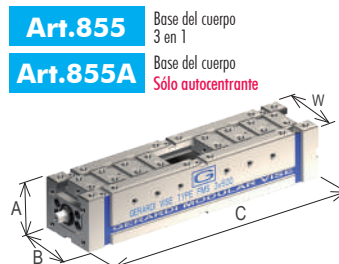

Anchura de la mordaza	Tipo W	2 (94mm) - 25kN			3 (124mm) - 30kN		4 (144mm) - 30kN	
Altura de la base A		90	90	90	100	100	120	
Anchura de la base B		95	95	95	125	125	145	
Longitud de la base C		400	500	600	500	600	600	
Ref.	<b>Art.855</b>	5.85.52400	5.85.52500	5.85.52600	5.85.53500	5.85.53600	5.85.54600	
PRECIO €		1.325	1.794	1.981	1.721	2.380	2.192	
Ref.	<b>Art.855A</b>	5.85.5240A	5.85.5250A	5.85.5260A	5.85.5350A	5.85.5360A	5.85.5460A	
PRECIO €		1.404	1.890	2.052	1.809	2.484	2.268	

### COMPONGA SU MORDAZA CON LOS CIENTOS DE MORDAZAS DISPONIBLES

#### CONFIGURACIÓN DE DOBLE SUJECIÓN

**Art.860**  
Mordazas dobles con boca dentada

Tipo	2			3		4
Ref.	5.86.02400	5.86.02500	5.86.02600	5.86.03500	5.86.03600	5.86.04600
PRECIO €	<del>1.741</del>	<del>2.214</del>	<del>2.399</del>	<del>2.198</del>	<del>2.855</del>	<del>2.823</del>
PRECIO ESPECIAL €	1.400	1.800	1.950	1.800	2.300	2.300

**Art.863**  
Mordazas dobles con paso

Tipo	2			3		4
Ref.	5.86.32400	5.86.32500	5.86.32600	5.86.33500	5.86.33600	5.86.34600
PRECIO €	<del>1.895</del>	<del>2.365</del>	<del>2.551</del>	<del>2.349</del>	<del>3.007</del>	<del>3.013</del>
PRECIO ESPECIAL €	1.550	1.900	2.100	1.900	2.450	2.450

**Art.865**  
Mordaza doble con bocas desplegables de cambio rápido (sistema de peine)

Tipo	2			3		4
Ref.	5.86.52400	5.86.52500	5.86.52600	5.86.53500	5.86.53600	5.86.54600
PRECIO €	<del>2.058</del>	<del>2.528</del>	<del>2.716</del>	<del>2.655</del>	<del>3.318</del>	<del>3.436</del>
PRECIO ESPECIAL €	1.700	2.100	2.200	2.200	2.700	2.800

**Art.866**  
Mordaza doble con bocas escalonadas flotantes (3x5)

Tipo	2			3		4
Ref.	5.86.62400	5.86.62500	5.86.62600	5.86.63500	5.86.63600	5.86.64600
PRECIO €	<del>2.176</del>	<del>2.648</del>	<del>2.833</del>	<del>2.680</del>	<del>3.338</del>	<del>3.292</del>
PRECIO ESPECIAL €	1.800	2.200	2.300	2.200	2.700	2.700

**Art.867**  
Mordaza doble con bocas escalonadas flotantes y placas ajustables

Tipo	2			3		4
Ref.	5.86.72400	5.86.72500	5.86.72600	5.86.73500	5.86.73600	5.86.74600
PRECIO €	<del>2.541</del>	<del>2.959</del>	<del>3.197</del>	<del>3.078</del>	<del>3.737</del>	<del>3.761</del>
PRECIO ESPECIAL €	1.999	2.328	2.516	2.423	2.941	2.960

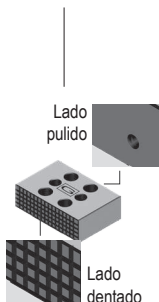

#### \* CONFIGURACIÓN SÓLO AUTOCENTRANTE

Base del cuerpo - **Sólo autocentrante**

**Art.855A** + **Art.810** = **Art.860A**  
2 bocas dentadas

Tipo	2		3		4	
* PRECIO €	1.599	2.072	2.257	2.038	2.695	2.603

\* SÓLO para configuración autocentrante, espaciador Art.850T incluido en el precio

Base del cuerpo - **Sólo autocentrante**

**Art.855A** + **Art.810L** = **Art.863A**  
2 Bocas con paso

Tipo	2		3		4	
* PRECIO €	1.671	2.141	2.328	2.108	2.765	2.694

\* SÓLO para configuración autocentrante, espaciador Art.850T incluido en el precio

Base del cuerpo - **Sólo autocentrante**

**Art.855A** + **Art.807** = **Art.865A**  
2 Bocas desplegables de cambio rápido

Tipo	2		3		4	
* PRECIO €	1.792	2.262	2.450	2.264	2.927	2.920

\* For self-centering configuration ONLY, spacer Art.850T included in the price

Base del cuerpo - **Sólo autocentrante**

**Art.855A** + **Art.814** (nº2) + **Art.805V** (nº2) = **Art.868A**

Tipo	2		3		4	
* PRECIO €	2.051	2.502	2.676	2.514	3.151	3.231

\* SÓLO para configuración autocentrante, espaciador Art.850T incluido en el precio

Base del cuerpo - **Sólo autocentrante**

**Art.855A** + **Art.810J** = **Art.870A**  
2 Bocas prismáticas

Tipo	2		3		4	
* PRECIO €	1.827	2.298	2.483	2.307	2.965	3.017

\* SÓLO para configuración autocentrante, espaciador Art.850T incluido en el precio

PERFECTAS PARA CENTOS DE 5 EJES

## PARA SUJECCIÓN MÚLTIPLE DE 1 A 19 PIEZAS DE VARIOS TAMAÑOS - PERFECTAS PARA MÁQUINAS VERTICALES Y HORIZONTALES

### Art.600/W

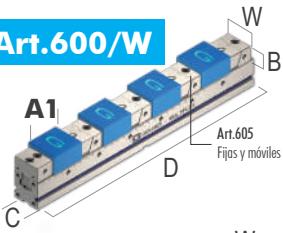

Equipamiento estándar : 1 llave en "T", 2 tuercas de posicionamiento y 4 topes. Cada mordaza se suministra con 4 piezas de sujeción.  
**+ 6 Pinzas de sujeción Art.298** (\* Tipos suministrados para sujeción de 3 piezas)

### Art.606

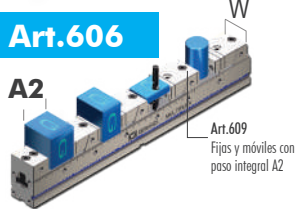

### Art.611

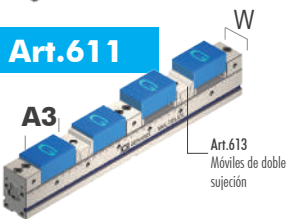

Tipo	Art.600 / Art.600W						Art.606				Art.611						
	mm	B	C <sup>+0 -0,02</sup>	D	W	A1 mm	Ref.	PRECIO €	PRECIO ESPECIAL €	A2 mm	Ref.	PRECIO €	PRECIO ESPECIAL €	A3 mm	Ref.	PRECIO €	PRECIO ESPECIAL €
1 20kN	32/25	50	300	49	4x8	6.60.01300		<del>1.168</del>	<b>749</b>	*3x19	6.60.61300	<del>1.768</del>	<b>1.200</b>	3x21	6.61.11300	<del>1.768</del>	<b>1.200</b>
	32/25	50	400	49	4x33	6.60.01400		<del>1.269</del>	<b>849</b>	4x23	6.60.61400	<del>1.842</del>	<b>1.300</b>	4x46	6.61.11400	<del>1.842</del>	<b>1.300</b>
	32/25	50	500	49	4x58	6.60.01500		<del>1.383</del>	<b>949</b>	4x48	6.60.61500	<del>1.954</del>	<b>1.400</b>	4x71	6.61.11500	<del>1.954</del>	<b>1.400</b>
	32/25	50	600	49	4x83	6.60.01600		<del>1.507</del>	<b>1.049</b>	4x73	6.60.61600	<del>2.078</del>	<b>1.500</b>	4x96	6.61.11600	<del>2.067</del>	<b>1.500</b>
	32/25	50	700	49	4x108	6.60.01700		<del>1.685</del>	<b>1.149</b>	4x97	6.60.61700	<del>2.259</del>	<b>1.600</b>	4x121	6.61.11700	<del>2.259</del>	<b>1.600</b>
2 30kN NEW	40	75	400	74	4x12	6.60.02400		<del>1.520</del>	<b>1.099</b>	*3x28	6.60.62400	<del>2.200</del>	<b>1.550</b>	4x34	6.61.12400	<del>2.200</del>	<b>1.550</b>
	40	75	500	74	4x37	6.60.02500		<del>1.632</del>	<b>1.249</b>	4x24	6.60.62500	<del>2.316</del>	<b>1.650</b>	4x59	6.61.12500	<del>2.316</del>	<b>1.650</b>
	40	75	600	74	4x62	6.60.02600		<del>1.758</del>	<b>1.349</b>	4x49	6.60.62600	<del>2.443</del>	<b>1.750</b>	4x84	6.61.12600	<del>2.443</del>	<b>1.750</b>
	40	75	700	74	4x87	6.60.02700		<del>1.883</del>	<b>1.449</b>	4x74	6.60.62700	<del>2.569</del>	<b>1.850</b>	4x109	6.61.12700	<del>2.569</del>	<b>1.850</b>
	40	75	800	74	4x112	6.60.02800		<del>2.052</del>	<b>1.549</b>	4x99	6.60.62800	<del>2.749</del>	<b>1.950</b>	4x134	6.61.12800	<del>2.749</del>	<b>1.950</b>
3 40kN	40	75	900	74	4x137	6.60.02900		<del>2.234</del>	<b>1.749</b>	4x124	6.60.62900	<del>2.933</del>	<b>2.050</b>	4x158,5	6.61.12900	<del>2.933</del>	<b>2.050</b>
	60	100	700	99	4x59	6.60.03700		<del>2.178</del>	<b>1.649</b>	4x44	6.60.63700	<del>2.967</del>	<b>2.150</b>	4x77	6.61.13700	<del>2.967</del>	<b>2.150</b>
	60	100	800	99	4x84	6.60.03800		<del>2.357</del>	<b>1.749</b>	4x69	6.60.63800	<del>3.150</del>	<b>2.250</b>	4x102	6.61.13800	<del>3.150</del>	<b>2.250</b>
	60	100	900	99	4x109	6.60.03900		<del>2.542</del>	<b>1.949</b>	4x94	6.60.63900	<del>3.331</del>	<b>2.450</b>	4x127	6.61.13900	<del>3.331</del>	<b>2.450</b>
	60	100	1000	99	4x134	6.60.03100		<del>2.785</del>	<b>2.149</b>	4x119	6.60.63100	<del>3.574</del>	<b>2.650</b>	4x152	6.61.13100	<del>3.574</del>	<b>2.650</b>

## PARA PLACAS PARALELAS MAGNÉTICAS Y PLACAS DE MORDAZAS PARALELAS

Art.616  
Par de platos magnéticos paralelos para Art. 600

DESCUENTO HASTA EL  
**27%**

\* Comprando una mordaza completa

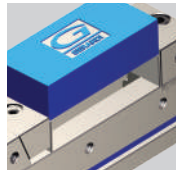

Art.610E  
Placa de mordaza paralela para Art.606

DESCUENTO HASTA EL  
**23%**

\* Comprando una mordaza completa

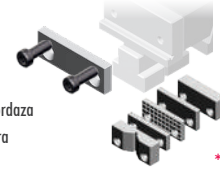

## MULTITASKING VISES

## MORDAZAS AUTOCENTRANTES Y EXCÉNTRICAS - PERFECTAS PARA CENTROS DE MECANIZADO DE 5 EJES

### Art.640

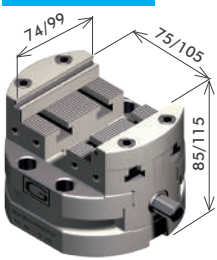

Equipamiento estándar : 1 tope, 1 llave hexagonal, par de tuercas de posicionamiento Art.297, 1 pasador recto Art.640P

! Posibilidad de solicitar 2 mordazas Art.645T en vez de Art.645E

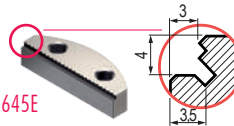

DESCUENTO HASTA EL  
**22%**

Tipo	1	2	3x166	3x266
Ref.	6.64.01000	6.64.02000	7.64.03166	7.64.03266
PRECIO €	<del>1.720</del>	<del>2.115</del>	<del>2.460</del>	<del>2.578</del>
PRECIO ESP. €	<b>1.049</b>	<b>1.249</b>	<b>2.039</b>	<b>2.124</b>

Mordaza simple elevadora Art.640

Tipo	1	2	3x166	3x266
Ref.	7.64.1H100AL /100	7.64.1H200AL /100	7.64.1H3166AL /100	7.64.1H3266AL /100
PRECIO €	<del>621</del>	<del>731</del>	<del>746</del>	<del>1.133</del>
PRECIO ESP. €	<b>400</b>	<b>450</b>	<b>600</b>	<b>900</b>

Torretas de acero con punto cero para Art.640 para cambio rápido  
 Equipamiento estándar : 1 Perno Art.10S / 11S 1 tapón de teflón con junta tórica Art.9  
 1 pasador de posicionamiento Art.640P, 1 tornillo sin cabeza calibrado Art.79

Tipo	1	2	2
Art.64			
Altura H	100	125	163
Ref.	9.63.10000	9.63.20000	9.64.20000
PRECIO €	<del>1.143</del>	<del>1.914</del>	<del>3.347</del>
PRECIO ESP. €	<b>949</b>	<b>1.449</b>	-

Art.645B  
Liso

Tipo	1	2	3
Ref.	6.64.5B100	6.64.5B200	6.64.5B300
PRECIO €	<del>99</del>	<del>118</del>	<del>154</del>
PRECIO ESPECIAL €	<b>77</b>	<b>93</b>	<b>121</b>

Art.645C  
Pulido

Tipo	1	2	3
Ref.	6.64.5C100	6.64.5C200	6.64.5C300
PRECIO €	<del>99</del>	<del>118</del>	<del>154</del>
PRECIO ESPECIAL €	<b>77</b>	<b>93</b>	<b>121</b>

Art.645D  
Dentada

Tipo	1	2	3
Ref.	6.64.5D100	6.64.5D200	6.64.5D300
PRECIO €	<del>99</del>	<del>118</del>	<del>154</del>
PRECIO ESPECIAL €	<b>77</b>	<b>93</b>	<b>121</b>

Art.645E  
Con paso

Tipo	1	2	3
Ref.	6.64.5E100	6.64.5E200	6.64.5E300
PRECIO €	<del>111</del>	<del>130</del>	<del>166</del>
PRECIO ESPECIAL €	<b>87</b>	<b>102</b>	<b>130</b>

Art.645F  
Prismática

Tipo	1	2	2
Ref.	6.64.5F100	6.64.5F200	6.64.5F300
PRECIO €	<del>125</del>	<del>141</del>	<del>179</del>
PRECIO ESPECIAL €	<b>98</b>	<b>111</b>	<b>141</b>

Art.645T  
De sujeción EQUIPADA

Tipo	1	2	2
Ref.	6.64.5T100	6.64.5T200	6.64.5T300
PRECIO €	<del>125</del>	<del>141</del>	<del>179</del>
PRECIO ESPECIAL €	<b>98</b>	<b>111</b>	<b>141</b>



Válido hasta el 31 de Diciembre 2023

FUNDICIÓN DE HIERRO FUNDIDO SÓLIDO CON DOBLE TRATAMIENTO TÉRMICO DE ALIVIO DE TENSIONES - PERFECTO PARA CENTROS DE MECANIZADO HORIZONTALES

## ESTÁNDAR JAPONÉS

### Art.53B

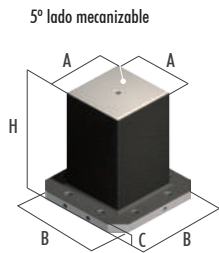

Ref.	A	B	C	D	H	kg	PRECIO €	ESPECIAL P.€
8.53.B00080	260	400	45	-	550	197	<del>1.799</del>	1.550
8.53.B00081	260	400	45	-	660	228	<del>2.076</del>	1.690
8.53.B00100	260	500	45	-	650	255	<del>2.346</del>	2.000
8.53.B00105	260	500	45	-	750	284	<del>2.432</del>	2.000
8.53.B00115	310	500	45	-	900	383	<del>3.447</del>	2.700
8.53.B00171	360	500	45	-	700	356	<del>3.231</del>	2.500
8.53.B00180	360	630	45	-	820	452	<del>4.094</del>	3.200
*8.53.B00211	510	630	45	-	860	61	<del>5.687</del>	3.550

\* Only for pallets with "T" slots

### Art.55B

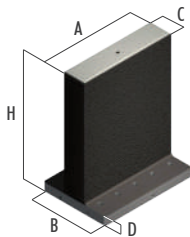

Ref.	A	B	C	D	H	kg	PRECIO €	ESPECIAL P.€
8.55.B00052	410	400	160	50	660	244	<del>2.276</del>	1.800
8.55.B00053	510	500	160	50	700	331	<del>3.039</del>	2.400
8.55.B00054	510	500	210	55	600	316	<del>2.953</del>	2.300
8.55.B00170	640	450	160	55	820	460	<del>4.220</del>	3.200
8.55.B00172	640	630	210	55	850	545	<del>5.027</del>	3.540
8.55.B00190	810	450	160	65	800	604	<del>5.635</del>	4.040

### Art.57B

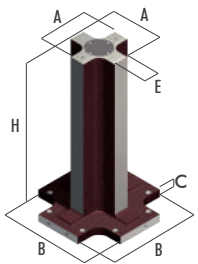

Ref.	A	B	C	E	H	kg	PRECIO €	ESPECIAL P.€
8.57.B00100	210	500	50	80	750	157	<del>1.632</del>	1.500
8.57.B00110	280	500	50	80	850	235	<del>2.024</del>	1.900
8.57.B00120	240	500	50	110	850	218	<del>1.951</del>	1.750
8.57.B00130	310	500	50	150	850	269	<del>2.348</del>	2.000
8.57.B00140	310	630	50	150	950	327	<del>2.657</del>	2.350

### Art.53B2 PLUS

Ref.	kg	PRECIO €	ESPECIAL P.€
8.53.B20080	182	<del>2.292</del>	1.950
8.53.B20081	204	<del>2.601</del>	2.050
8.53.B20100	238	<del>2.938</del>	2.400
8.53.B20105	254	<del>3.046</del>	2.500
8.53.B20115	354	<del>4.185</del>	3.300
8.53.B20171	326	<del>3.923</del>	3.050
8.53.B20180	427	<del>5.123</del>	4.000
8.53.B20211	593	<del>6.905</del>	4.350

### Art.55B2 PLUS

Ref.	kg	PRECIO €	ESPECIAL P.€
8.55.B20052	206	<del>2.763</del>	2.150
8.55.B20053	303	<del>3.690</del>	2.900
8.55.B20054	301	<del>3.585</del>	2.800
8.55.B20170	433	<del>5.124</del>	4.000
8.55.B20172	520	<del>6.104</del>	4.300
8.55.B20190	782	<del>6.842</del>	4.900

### Art.57B2 PLUS

Ref.	kg	PRECIO €	ESPECIAL P.€
8.57.B20100	155	<del>2.014</del>	1.850
8.57.B20110	241	<del>2.532</del>	2.300
8.57.B20120	216	<del>2.481</del>	2.250
8.57.B20130	232	<del>2.887</del>	2.450
8.57.B20140	325	<del>3.197</del>	2.650

**A** Una pieza integral de hierro fundido G30 desbastada con tratamiento térmico de doble alivio de tensión. Espesor de pared 43-45 mm. Tolerancia +12 / -5 mm

**B** Fundición desbastada con la base mecanizada y raspada a mano para una sujeción directa sobre el pallet estándar japonés. Base con 4 agujeros de precisión Ø20F7 y roscas inferiores M16 con dimensiones de paso precisas para el uso de Punto Cero o para ser interfaz con otros pallets o placas del cabezal. Listo para su instalación y para ser mecanizado con su reajuste con el eje de la máquina. Tolerancia +12 / -5 mm

**C** Cubo completamente acabado con espesor de pared aproximado de 38-40 mm. Tolerancia ± 0,02 mm

**B2 PLUS** 1 mm de exceso en cada lado. Listo para su instalación y para ser mecanizado y reajustar con el eje de la máquina.

**E** Cubo integral con agujeros calibrados y roscas macizas. Tolerancia ± 0,02 mm

**F** Cubo integral con casquillo templado 100 Cr6 y helicoidales de acero inoxidable. Tolerancia ± 0,02 mm.

## MORDAZA DE CUBO INTEGRAL CON PLACA BASE

### Art.53B1

Cubo liso  
Base terminada

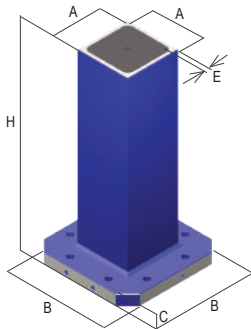

DESCUENTO HASTA EL **20%**

### Art.55B1

2 caras de la torreta lisas  
Base terminada

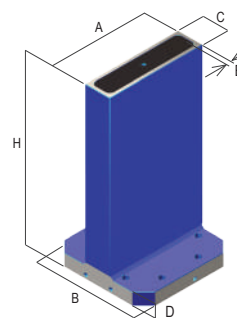

DESCUENTO HASTA EL **20%**

Dimensiones									
A	B	C	E	H	kg	Ref.	PRECIO €	SPECIAL PRICE €	
210	400	45	25	750	167	8.53.B10055	<del>1.799</del>	1.500	
260	400	45	25	850	229	8.53.B10085	<del>2.169</del>	1.800	
260	500	45	25	750	234	8.53.B10105	<del>2.367</del>	1.950	
360	500	45	30	900	400	8.53.B10182	<del>3.352</del>	2.700	
360	630	45	30	950	468	8.53.B10185	<del>4.014</del>	3.250	
460	630	45	35	950	634	8.53.B10205	<del>5.010</del>	4.050	

E= Grosor de la pared

Dimensiones									
A	B	C	D	E	H	kg	Ref.	PRECIO €	PRECIO ESPECIAL €
400	400	110	55	25	750	193	8.55.B10045	<del>2.049</del>	1.700
400	400	160	55	25	850	239	8.55.B10050	<del>2.274</del>	1.900
500	500	160	55	25	750	277	8.55.B10053	<del>2.676</del>	2.200
500	500	210	55	30	900	402	8.55.B10085	<del>3.428</del>	2.800
630	630	210	55	30	950	553	8.55.B10172	<del>4.614</del>	3.700

E= Grosor de la pared



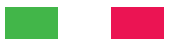

Válido hasta el 31 de Diciembre 2023

TIEMPOS DE CONFIGURACIÓN REDUCIDOS EN UN 90%, REPETIBILIDAD DENTRO DE 0,005 MM - PERFECTOS PARA CENTROS VERTICALES Y HORIZONTALES

## EL CLÁSICO NEUMÁTICO MÚLTIPLE

Equipamiento estándar: 1 perno Art.11A  
1 Tapón de teflón con junta tórica Art.9

## EL HERMÉTICO NEUMÁTICO ÚNICO



Tipo	1	2	3
Ref.	9.66.41000	9.66.42000	9.66.43000
kN	5,4	10	16
Efecto doble kN	NOT AVAILABLE		
PRECIO €	<del>613</del>	<del>923</del>	<del>1.159</del>
OFERTA €	€ 499	€ 599	€ 999

Tipo	1	2	3
Ref.	9.66.51000	9.66.52000	9.66.53000
kN	5,4	10	16
Efecto doble kN	NOT AVAILABLE		
PRECIO €	<del>494</del>	<del>801</del>	<del>1.043</del>
OFERTA €	€ 399	€ 499	€ 899

Tipo	1	2	3
Ref.	9.66.4S100	9.66.4S200	9.66.4S300
kN	5,4	10	16
Efecto doble kN	12,7	27	40
PRECIO €	<del>710</del>	<del>1.006</del>	<del>1.159</del>
OFERTA €	€ 599	€ 699	€ 999

Tipo	1	2	3
Ref.	9.66.5S100	9.66.5S200	9.66.5S300
kN	5,4	10	16
Efecto doble kN	12,7	27	40
PRECIO €	<del>592</del>	<del>887</del>	<del>1.043</del>
OFERTA €	€ 499	€ 599	€ 899

Fuerza de sujeción 5 ÷ 40 kN / Fuerza de retención superior a 60 kN / Desbloqueo neumático 6 ÷ 14 bar / Compensación axial y radial gracias a la pinza elástica integrada / Tirantes de doble centrado para máxima rigidez / Depuración del aire / Solo para PUNTO CERO ÚNICO (versión S): 4 CHAVETEROS y FUNCIÓN DOBLE EFECTO

## KIT PUNTO CERO NEUMÁTICO PLACAS BASE CON INTERFAZ

KIT #1 & #2 POSICIONAMIENTO Y BLOQUEO INCLUIDOS

KIT #3 & #4 POSICIONAMIENTO Y BLOQUEO ESTÁNDAR INCLUIDOS, BLOQUEO ESPECÍFICO **EXTRA\***

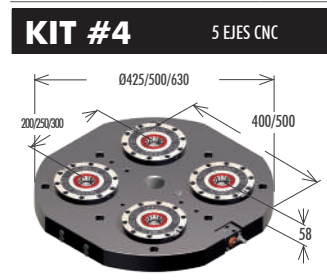
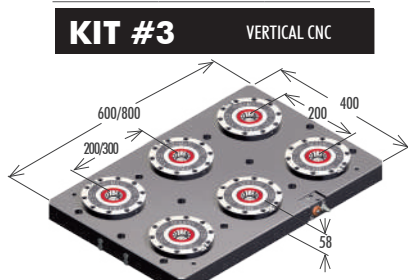
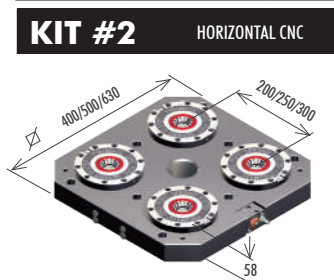
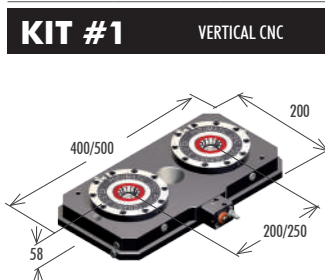

**Art.81P PLACA BASE**

	200x400	200x500
PRECIO €	<del>2.644</del>	<del>2.711</del>
ESPECIAL P.€	1.749	1.849

**Art.80P PLACA BASE**

	400x400	500x500	630x630
PRECIO €	<del>4.737</del>	<del>4.958</del>	<del>5.432</del>
ESPECIAL P.€	3.199	3.399	3.899

**Art.81P PLACA BASE**

	400x600	400x800
PRECIO €	<del>6.830</del>	<del>7.118</del>
ESPECIAL P.€	4.499	4.799

**Art.82P PLACA BASE REDONDA**

	Ø425	Ø500	Ø630
PRECIO €	<del>4.956</del>	<del>4.936</del>	<del>5.508</del>
ESPECIAL P.€	3.399	3.499	3.999

## PLACAS DE INTERFAZ PARA PLACAS BASE PUNTO CERO \*Contact Us and require the technical drawing

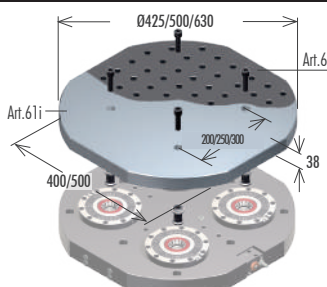
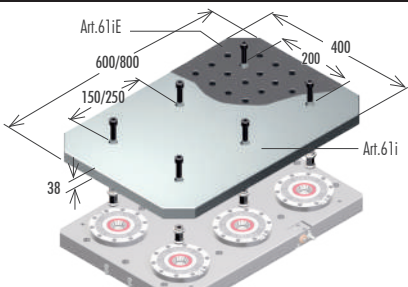
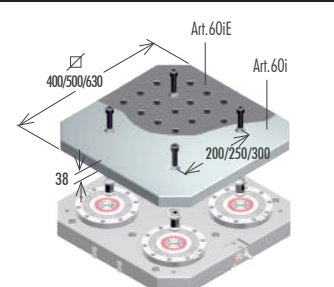
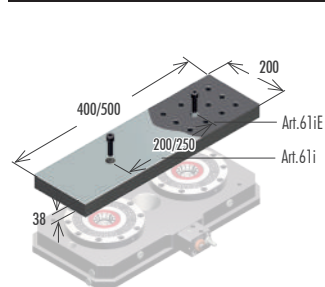

**Art.61iC PULIDO**

	200x400	200x500
PRECIO €	<del>908</del>	<del>976</del>
SPECIAL P.€	549	649

**Art.61iE MATRIZ INTEGRADA**

	200x400	200x500
PRECIO €	<del>1.101</del>	<del>1.213</del>
SPECIAL P.€	649	749

**Art.60iC PULIDO**

	400x400	500x500	630x630
PRECIO €	<del>1.112</del>	<del>1.339</del>	<del>1.679</del>
SPECIAL P.€	863	1.039	1.303

**Art.60iE MATRIZ INTEGRADA**

	400x400	500x500	630x630
PRECIO €	<del>1.461</del>	<del>1.910</del>	<del>3.000</del>
SPECIAL P.€	1.040	1.360	2.136

**Art.61iC PULIDO**

	400x600	400x800
PRECIO €	<del>1.701</del>	<del>2.268</del>
SPECIAL P.€	1.320	1.760

**Art.61iE MATRIZ INTEGRADA**

	400x600	400x800
PRECIO €	<del>2.022</del>	<del>2.875</del>
SPECIAL P.€	1.440	2.048

**Art.62iC PULIDO**

	Ø425	Ø500	Ø630
PRECIO €	<del>1.192</del>	<del>1.361</del>	<del>1.588</del>
SPECIAL P.€	924	1.056	1.232

**Art.62iE MATRIZ INTEGRADA**

	Ø425	Ø500	Ø630
PRECIO €	<del>1.461</del>	<del>1.865</del>	<del>2.494</del>
SPECIAL P.€	1.040	1.328	1.776



Válido hasta el 31 de Diciembre 2023

## MORDAZA HIDRÁULICA O NEUMÁTICA DE DOBLE EFECTO - PERFECTA PARA CENTROS DE MECANIZADO DE 5 EJES

### Art.670

Base de mordaza neumática o hidráulica, ideal para centros de mecanizado de 5 ejes



Equipamiento estándar: - 4x Tornillos calibrados (Art.83) - Pasador de centrado (Art.670P) - 2 Niplon o 2 Art.PNO4 - Sin válvula de retorno (Art.PN16)

Tipo	2	3	4
Anchura de la boca W	74	99	124
Max apertura A	6,4	8,5	12
<b>Max apertura A1</b>	<b>88,9</b>	<b>130,2</b>	<b>162</b>
Altura de la mordaza C+B	105	135	165
Altura de la base C	80	105	130
Longitud de la base D	106	166	206
Longitud de la boca E	52	78	96
Orificios de centrado y fijación H	90	140	170
Presión del aire	Max 10BAR		
<b>Fuerza de sujeción</b>	<b>7 kN</b>	<b>14,4 kN</b>	<b>16,9 kN</b>
ART.670 Neumática - Ref.	7.67.OPN20	7.67.OPN30	7.67.OPN40
Presión	30BAR	30BAR	25 BAR
<b>Fuerza de sujeción</b>	<b>19 kN</b>	<b>37,5 kN</b>	<b>47 kN</b>
ART.670 Hidráulico - Ref.	7.67.OID20	7.67.OID30	7.67.OID40
PRECIO €	<del>1.737</del>	<del>2.317</del>	<del>3.069</del>
<b>PRECIO ESPECIAL €</b>	<b>1.400</b>	<b>1.850</b>	<b>2.400</b>

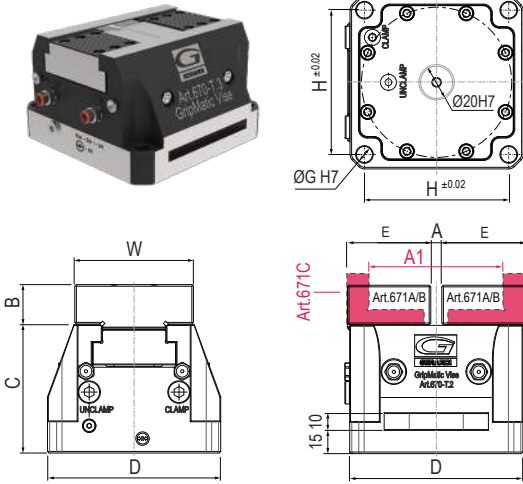

**Art.671A**  
Lisa



**Art.671B**  
Lisa y estrecha

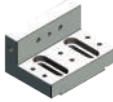

**Art.671C**  
Para placas estándar de anchura estrecha



**Art.243**  
Placa recta con ranura endurecida



**Art.245**  
Placa recta lisa endurecida



**Art.247G**  
Recta con placas GRIP

## PLACA DE INTERFAZ PARA MORDAZAS GRIP MATIC - PERFECTA PARA CENTROS DE MECANIZADO DE 5 EJES

### Art.670CP

## SEMI-AUTOMÁTICO

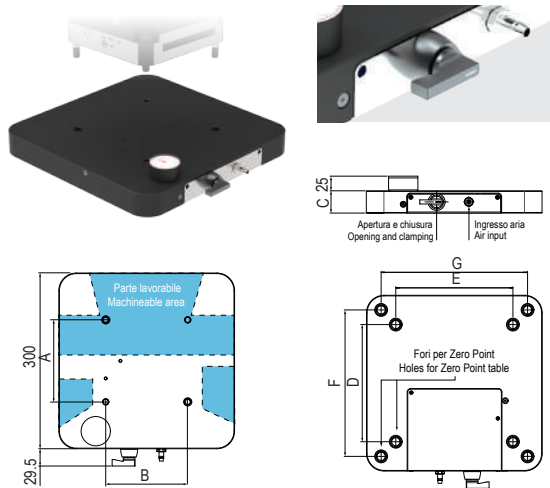

Placa de interfaz para mordaza GripMatic Art.670PN con acoplamiento rápido semiautomático entrada de aire y control manual del sistema a través de un selector.



Tipo	2	3	4
Paso de los agujeros A	90	140	170
Paso de los agujeros B	90	140	170
Altura del plato C	38	38	38
Paso de los agujeros (Punto Cero) D	200	200	200
Paso de los agujeros (Punto Cero) E	200	200	200
Paso de los agujeros (Punto Cero) F	250	250	250
Paso de los agujeros (Punto Cero) G	250	250	250
Presión del aire	Max 10BAR		
<b>Fuerza de sujeción</b>	<b>7 kN</b>	<b>14,4 kN</b>	<b>16,9 kN</b>
Ref.	7.67.OCP20	7.67.OCP30	7.67.OCP40
PRECIO €	2.204	2.204	2.204

### Art.670AP

## AUTOMÁTICO

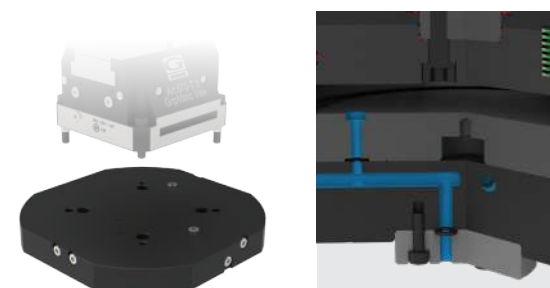

Placa de interfaz para mordaza GripMatic Art.670PN automática con entrada de aire a través de la mesa de la máquina y posibilidad de ser controlado directamente por el CNC. Esta placa se puede personalizar completamente según las características de la máquina (comprobación del posicionamiento de la pieza y limpieza).



\* Precio mínimo, PERSONALIZACIÓN INCLUIDA

### PLACA 100% PERSONALIZABLE

Tipo	2	3	4
Presión del aire	Max 10BAR		
<b>Fuerza de sujeción</b>	<b>7 kN</b>	<b>14,4 kN</b>	<b>16,9 kN</b>
ART.670 Neumática - Ref.	7.67.OAP20	7.67.OAP30	7.67.OAP40
PRECIO € *	2.424	2.424	2.424



## CUADRADA, RECTANGULAR Y REDONDA - PERFECTA PARA CENTROS DE MECANIZADO VERTICALES Y HORIZONTALES

### PLACAS BASE CUADRADAS (ACERO) - PERFECTAS PARA CENTROS DE MECANIZADO VERTICALES Y HORIZONTALES

#### Art. 60C

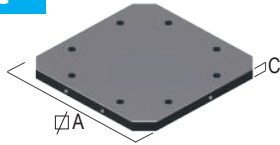

Placa base de palet lisa a medida. Rectificado a dos caras.

A	C	Kg	Ref.	PRECIO €	PRECIO ESPECIAL €
400	38	45	8.60.C40404S	<del>1.112</del>	<b>899</b>
500	38	70	8.60.C50504S	<del>1.339</del>	<b>1.099</b>
630	38	115	8.60.C63634S	<del>1.679</del>	<b>1.349</b>
800	38	180	8.60.C80804S	<del>2.200</del>	<b>1.799</b>

#### Art. 60E

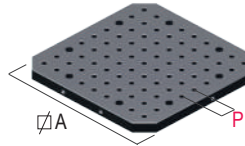

P = Paso 40 o 50mm

Matriz hecha a medida con orificios y roscas calibrados.

A	C	Kg	Ref.	PRECIO €	PRECIO ESPECIAL €	P= 40		P= 50	
						PRECIO €	PRECIO ESPECIAL €	PRECIO €	PRECIO ESPECIAL €
400	48	55	8.60.E40400S	<del>1.798</del>	<b>1.299</b>	<del>1.461</del>	<b>1.099</b>		
500	48	85	8.60.E50500S	<del>2.359</del>	<b>1.699</b>	<del>1.910</del>	<b>1.399</b>		
630	48	135	8.60.E63630S	<del>3.617</del>	<b>2.599</b>	<del>3.000</del>	<b>2.199</b>		
800	48	240	8.60.E80800S	<del>5.616</del>	<b>4.099</b>	<del>3.932</del>	<b>2.900</b>		

#### Art. 60H

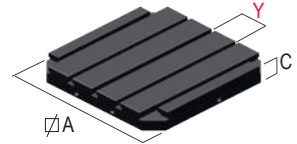

Hecho a medida con ranuras paralelas.

Deben incluirse las medidas X & Y

A	C	X*	Y	Kg	Ref.	PRECIO €	PRECIO ESPECIAL €
400	73	16	100	80	8.60.H40400S	<del>1.910</del>	<b>1.499</b>
500	73	16	100	115	8.60.H50500S	<del>2.696</del>	<b>2.099</b>
630	73	16	100	205	8.60.H63630S	<del>3.932</del>	<b>2.999</b>
800	73	16	100	290	8.60.H80800S	<del>4.493</del>	<b>3.499</b>

\* X = 16mm y 18mm estándar. Otras medidas bajo pedido

### PLACAS BASE RECTANGULARES (ACERO) - PERFECTAS PARA CENTROS DE MECANIZADO VERTICALES

#### Art. 61C

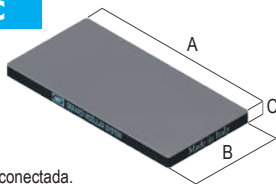

Placa base lisa interconectada. Tapas rectificadas.

A	B	C	Kg	Ref.	LIST PRICE €	SPECIAL PRICE €
600	400	38	71	8.61.C40600S	<del>1.701</del>	<b>1.399</b>
600	500	38	89	8.61.C50600S	<del>1.928</del>	<b>1.549</b>
800	400	38	95	8.61.C40800S	<del>2.268</del>	<b>1.799</b>
900	450	38	120	8.61.C45900S	<del>2.835</del>	<b>2.299</b>
1000	500	38	149	8.61.C50100S	<del>3.402</del>	<b>2.699</b>

#### Art. 61E

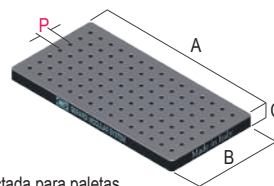

P = Paso 40 o 50mm

Placa base con rejilla interconectada para paletas con orificios calibrados y roscados integrados.

A	B	C	Kg	Ref.	LIST PRICE €	SPECIAL PRICE €
600	400	38	90	8.61.E40600S	<del>2.022</del>	<b>1.499</b>
600	500	38	112	8.61.E50600S	<del>2.472</del>	<b>1.799</b>
800	400	38	119	8.61.E40800S	<del>2.875</del>	<b>2.099</b>
900	450	38	150	8.61.E45900S	<del>3.370</del>	<b>2.499</b>
1000	500	38	188	8.61.E50100S	<del>3.932</del>	<b>2.899</b>

#### Art. 61H

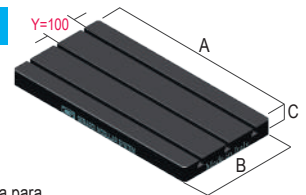
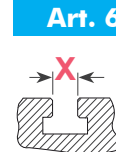

Placa base interconectada para paletas con ranuras paralelas.

Deben incluirse las medidas X & Y

A	B	C	X*	Y	Kg	Ref.	LIST PRICE €	SPECIAL PRICE €
600	400	73	16	122	122	8.61.H40600S	<del>2.472</del>	<b>1.899</b>
600	500	73	16	155	155	8.61.H50600S	<del>3.370</del>	<b>2.599</b>
800	400	73	16	165	165	8.61.H40800S	<del>3.033</del>	<b>2.399</b>
900	450	73	16	212	212	8.61.H45900S	<del>4.493</del>	<b>3.499</b>
1000	500	73	16	237	237	8.61.H50100S	<del>5.055</del>	<b>3.899</b>

\* X = 16mm y 18mm estándar. Otras medidas bajo pedido

Tolerancia ± 0,02 mm, Paso 40mm = Ø 12 / M10 - Paso 50mm = Ø 16 / M12

### PLACAS BASE REDONDAS (ACERO) - PERFECTAS PARA CENTROS DE MECANIZADO VERTICALES

#### Art. 62C

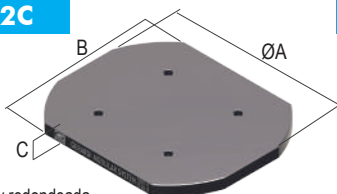

Placa base lisa y redondeada. Caras rectificadas.

A	B	C	Kg	Ref.	LIST PRICE €	SPECIAL PRICE €
400	320	38	37	8.62.C4032S	<del>1.192</del>	<b>949</b>
500	400	38	58	8.62.C5040S	<del>1.361</del>	<b>1.099</b>
630	500	38	93	8.62.C6350S	<del>1.588</del>	<b>1.299</b>
800	630	38	-	8.62.C8063S	<del>2.042</del>	<b>1.599</b>

#### Art. 62E

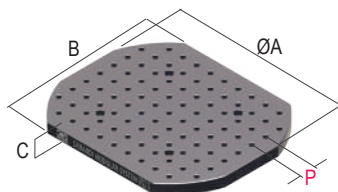

P = Paso 40 o 50mm

Placa base redondeada con orificios calibrados y roscas.

A	B	C	Kg	Ref.	LIST PRICE €	SPECIAL PRICE €
400	320	38	37	8.62.E4032S	<del>1.461</del>	<b>1.099</b>
500	400	38	58	8.62.E5040S	<del>1.865</del>	<b>1.399</b>
630	500	38	93	8.62.E6350S	<del>2.494</del>	<b>1.799</b>
800	630	38	150	8.62.E8063S	<del>3.617</del>	<b>2.599</b>

#### Art. 62H

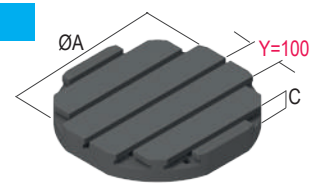

Placa base de palet redonda con ranuras paralelas.

Deben incluirse las medidas X & Y

A	C	X*	Y	Kg	Ref.	LIST PRICE €	SPECIAL PRICE €
400	73	16	-	-	8.62.H4032S	<del>1.910</del>	<b>1.499</b>
500	73	16	-	-	8.62.H5040S	<del>2.696</del>	<b>2.099</b>
630	73	16	-	-	8.62.H6350S	<del>3.932</del>	<b>2.999</b>
800	73	16	-	-	8.62.H8063S	<del>4.493</del>	<b>3.499</b>

\* X = 16mm y 18mm estándar. Otras medidas bajo pedido

Tolerancia ± 0,02 mm, Paso 50mm = Ø 16 / M12



Válido hasta el 31 de Diciembre 2023

**AHORRE EN LA COMPRA DE PORTAHERRAMIENTAS FIJOS - ELIJA ENTRE UNA AMPLIA GAMA EN EL CATÁLOGO**



**ESCANEA EL Código QR Y ELIGE ENTRE UNA AMPLIA GAMA DEL CATÁLOGO**

DIN 69880

**DMG MORI**

**Mazak**

**LOKUMA**

**BMT**  
Bolt Mounted Turret



**Nakamura-Tome**

**PTW**  
TSUGAMI CORPORATION

Consulta la contraseña con tu proveedor

**EJEMPLO KIT 1**

**3 PCS**

COMPRANDO  
**3 HERRAMIENTAS FIJAS**

**DMG MORI**

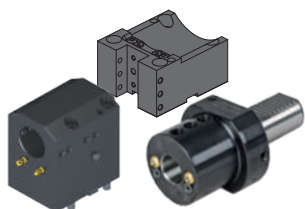

**BMT**

DIN 69880

DESCUENTO HASTA EL  
**10%**

**EJEMPLO KIT 2**

**4 PCS**

COMPRANDO  
**4 HERRAMIENTAS FIJAS**

**DMG MORI**

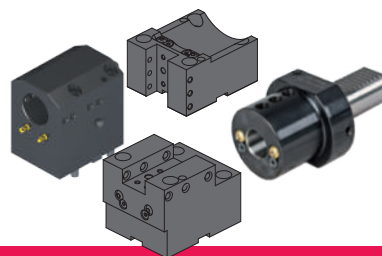

**BMT**

DIN 69880

**DMG MORI**

DESCUENTO HASTA EL  
**15%**

**ADAPTADORES  
UNIVERSALES DE CAMBIO RÁPIDO**

MADE IN ITALY



**2**  
AÑOS DE GARANTÍA

DESCUENTO HASTA EL  
**50%**



**NUEVOS TIPOS 2.0 - COMPATIBLES CON TODAS LAS SALIDAS ER**



**PATENTADO**  
PLACA DE DIAMANTE EXTRAÍBLE



**PRECIO 412€ UNIDAD**

- Reducción del tiempo de preparación y posibilidad de preajuste de herramientas fuera de línea.
- Adaptador modular universal de cambio rápido y PAR ELEVADO
- Sistema modular de portaherramientas adecuado para cada salida de pinza ER de Herramienta Motorizada.
- Mayor rigidez y prestaciones garantizadas en las herramientas motorizadas Gerardi gracias a la placa de diamante extraíble y a la tuerca de rodamiento de bolas.
- Todos los adaptadores modulares de cambio rápido 2.0 son adecuados para portaherramientas ER con suministro de refrigerante externo e interno.
- Utilizando los adaptadores de cambio rápido, sugerimos no superar las 10.000 Rpm
- También compatible con Preci-flex con tuerca interna

**¡HASTA FIN DE EXISTENCIAS!**

**3 PCS**

COMPRANDO  
**3 CAMBIOS RÁPIDOS UNIVERSALES**  
(TUERCAS INTERIORES O EXTERIORES)

**KIT1**



DESCUENTO HASTA EL  
**20%**

**4 PCS**

COMPRANDO  
**4 CAMBIOS RÁPIDOS UNIVERSALES**  
(TUERCAS INTERIORES O EXTERIORES)

**KIT2**



DESCUENTO HASTA EL  
**25%**

**WOOW**

COMPRANDO 1 HERRAMIENTA MOTORIZADA, SALIDA ER25, ER32 o ER40  
**1 ADAPTADOR DE CAMBIO RÁPIDO A ELECCIÓN**  
(TUERCAS INTERIORES O EXTERIORES)

**KIT3**



DESCUENTO HASTA EL  
**50%**

En cambio rápido



Válido hasta el 31 de Diciembre 2023

## HERRAMIENTAS MOTORIZADAS PARA TORNOS CNC - ¡MEJORE SU TORNO Y AUMENTE LA PRODUCTIVIDAD!

### BMT

Bolt Mounted Turret

COMPATIBLE CON

DOOSAN / HARDINGE / SAMSUNG / HWACHEON / HYTNDAU WUA / VICTOR / HAAS

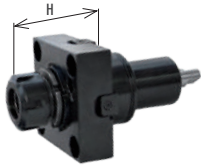

Axial



Radial



Ajustable

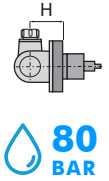

### ¡BMT 65 TAMBIÉN COMPATIBLE CON TORNOS HAAS!

BMT	Ref.	ER	H	Nm	Rpm	PRECIO €	PRECIO ESPECIAL €
45	99.DS.A03	25	Max 57,2	35	8000	<del>1.802</del>	<b>839</b>
	99.DS.A04	25	Max 57,2	35	8000	<del>1.144</del>	<b>929</b>
55	99.DS.A01	25	Max 57,2	40	8000	<del>1.323</del>	<b>899</b>
	99.DS.A02	25	Max 57,2	40	8000	<del>1.206</del>	<b>979</b>
<b>65</b> ILISTO PARA HAAS!	99.DS.A41	32	Max 72,5	70	6000	<del>1.236</del>	<b>1.049</b>
	99.DS.A42	32	Max 72,5	70	6000	<del>1.422</del>	<b>1.179</b>
75	99.DS.A34	40	Max 90,2	100	6000	<del>1.453</del>	<b>1.249</b>
	99.DS.A35	40	Max 90,2	100	6000	<del>1.669</del>	<b>1.399</b>

BMT	Ref.	ER	H	Nm	Rpm	PRECIO €	PRECIO ESPECIAL €
45	99.DS.A07C	25	65	35	8000	<del>1.768</del>	<b>1.499</b>
	99.DS.A08C	25	65	35	8000	<del>2.126</del>	<b>1.799</b>
55	99.DS.A11C	25	70	40	8000	<del>1.978</del>	<b>1.599</b>
	99.DS.A12C	25	70	40	8000	<del>2.337</del>	<b>1.899</b>
<b>65</b> ILISTO PARA HAAS!	99.DS.A51C	32	72	70	6000	<del>2.077</del>	<b>1.699</b>
	99.DS.A52C	32	72	70	6000	<del>2.460</del>	<b>1.999</b>
75	99.DS.A38C	40	60	100	6000	<del>3.214</del>	<b>2.649</b>
	99.DS.A39C	40	60	100	6000	<del>3.857</del>	<b>3.099</b>

BMT	Ref.	ER	H	Nm	Rpm	PRECIO €	PRECIO ESPECIAL €
45	99.DS.A16	20	65	15	8000	<del>4.561</del>	<b>3.899</b>
	99.DS.A17	20	65	15	8000	<del>5.933</del>	<b>4.699</b>
55	99.DS.A23	20	65	15	8000	<del>4.561</del>	<b>3.899</b>
	99.DS.A66	20	65	15	8000	<del>5.933</del>	<b>4.699</b>
<b>65</b> ILISTO PARA HAAS!	99.DS.A64	25	75	25	6000	<del>5.068</del>	<b>4.299</b>
	99.DS.A65	25	75	25	6000	<del>6.551</del>	<b>5.199</b>
75	99.DS.A47	25	75	25	6000	<del>5.068</del>	<b>4.299</b>
	99.DS.A48	25	75	25	6000	<del>6.551</del>	<b>5.199</b>

⚙️ Ambas direcciones de rotación del husillo disponibles\*

Espiga de mayor tamaño

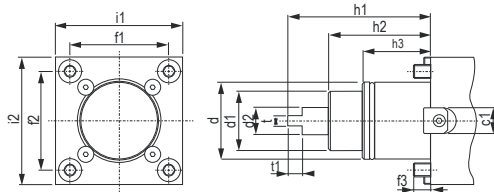

BMT	c1	d	d1	d2	f1	f2	f3	h1	h2	h3	i1	i2	t	t2	h4	N	ØM
45	15	Ø45	35	14	58	58	10	84	60	40	75	75	6	8,5	-	-	-
55	15	Ø55	40	16	64	64	14	104	75	30	85	85	8	8,5	9,5	8	29
65	18	Ø65	45	18	70	73	15	112	83	32	94	94	10	14	15	10	29
75	25	Ø75	55	23	90	90	15	110	80	43	112	112	14	15	-	-	-
85	25	Ø85	65	33,5	100	100	18	140	100	43	125	125	16	20	-	-	-

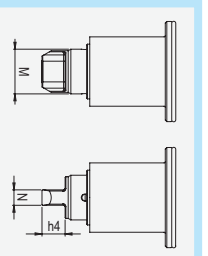

## OFERTA ESPECIAL EN LA NUEVA GAMA DE HERRAMIENTAS MOTORIZADAS BIMU 2022

### Mazak QTN3

QUICK TURN NEXUS QTN 300 / 350 / 400 / 450 - SQT 28 / 30 - 300

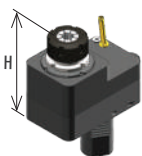

Eje desplazado



Ref.	ER	H	Nm	Rpm	PRECIO €	PRECIO ESPECIAL €
99.MZ.A71	40	145	100	4000	<del>3.223</del>	<b>3.000</b>
99.MZ.A72	40	145	100	4000	<del>3.525</del>	<b>3.200</b>



Radial



Ref.	ER	H	Nm	Rpm	PRECIO €	PRECIO ESPECIAL €
99.MZ.A75	40	160	100	4000	<del>3.324</del>	<b>3.100</b>
99.MZ.A81	40	160	100	4000	<del>3.828</del>	<b>3.500</b>

### LOKUMA VDI40

OKUMA CAPTAIN L370 M - ES L110 M - GENOS L300, L3000-E M/MY (VDI40)  
LB 300 MW - LB/LU 300 MY - LB/LU 300, 3000 M (VDI40)



Axial



Ref.	ER	H	Nm	Rpm	PRECIO €	PRECIO ESPECIAL €
99.OK.A18	32	98,6	70	6000	<del>1.890</del>	<b>1.499</b>
99.OK.A23	32	98,6	70	6000	<del>2.393</del>	<b>1.899</b>

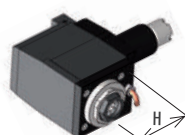

Radial



Ref.	ER	H	Nm	Rpm	LIST PRICE €	SPECIAL PRICE €
99.OK.A19	32	70	60	6000	<del>3.274</del>	<b>2.549</b>
99.OK.A25	32	70	60	6000	<del>4.030</del>	<b>3.149</b>

### TAKISAWA BMT60

EX 380/310/508/510/708/710/910 - EX 2000 M/Y - TC 350 MC - TT 350 MC - NEX 108/110/908/910 - LA 200/250 M/Y - LA 250 YS (15 stations) - FX 800 - MX 800 - VTL 450 M - LX 2500 M/Y



Axial



Ref.	ER	H	Nm	Rpm	PRECIO €	PRECIO ESPECIAL €
99.TK.A12	32	93	50	6000	<del>1.455</del>	<b>1.149</b>
99.TK.A13	32	93	50	6000	<del>2.148</del>	<b>1.699</b>

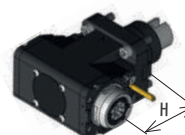

Radial



Ref.	ER	H	Nm	Rpm	PRECIO €	PRECIO ESPECIAL €
99.TK.A02	32	90	50	6000	<del>3.047</del>	<b>2.399</b>
99.TK.A05	32	90	50	6000	<del>3.235</del>	<b>2.549</b>



Válido hasta el 31 de Diciembre 2023

## HERRAMIENTAS MOTORIZADAS PARA TORNOS CNC - ¡MEJORE SU TORNO Y AUMENTE LA PRODUCTIVIDAD!

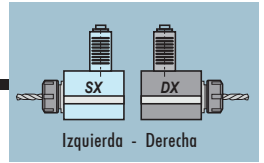

### DIN 5480

#### VDI - DIN69880



\* En caso de pedido, especifique siempre la orientación izquierda o derecha que necesita

d1	Ref.	ER	H	Nm	Rpm	PRECIO €	PRECIO ESPECIAL €
30	99.ST.8003	25	66	32	6000	<del>890</del>	<b>779</b>
	99.ST.8011	25	66	32	6000	<del>1.150</del>	<b>979</b>
40	99.ST.8005	32	95	63	6000	<del>1.113</del>	<b>999</b>
	99.ST.8013	32	95	63	6000	<del>1.455</del>	<b>1.229</b>

➡ Misma dirección de rotación que el husillo de la máquina

30	99.ST.8030	25	55	32	6000	<del>1.869</del>	<b>1.599</b>
	99.ST.8038	25	55	32	6000	<del>2.151</del>	<b>1.829</b>
40	99.ST.8033	32	100	63	6000	<del>2.365</del>	<b>1.999</b>
	99.ST.8041	32	100	63	6000	<del>2.716</del>	<b>2.299</b>

⬅ Dirección de rotación opuesta al husillo de la máquina

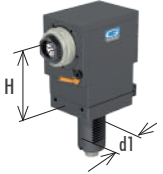

### DIN 5482

#### VDI - DIN69880



\* En caso de pedido, especifique siempre la orientación izquierda o derecha que necesita

d1	Ref.	ER	H	Nm	Rpm	PRECIO €	PRECIO ESPECIAL €
30	99.ST.8201	25	94	32	6000	<del>839</del>	<b>779</b>
	99.ST.8207	25	94	32	6000	<del>1.127</del>	<b>979</b>
40	99.ST.8203	32	115	63	5000	<del>1.010</del>	<b>899</b>
	99.ST.8208	32	115	63	5000	<del>1.307</del>	<b>1.129</b>

➡ Misma dirección de rotación que el husillo de la máquina

30	99.ST.8217	25	55	32	6000	<del>1.684</del>	<b>1.449</b>
	99.ST.8223	25	55	32	6000	<del>1.966</del>	<b>1.699</b>
40	99.ST.8220	32	100	63	5000	<del>2.017</del>	<b>1.699</b>
	99.ST.8226	32	100	63	5000	<del>2.359</del>	<b>1.999</b>

⬅ Dirección de rotación opuesta al husillo de la máquina

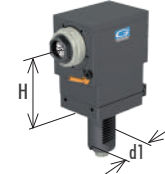
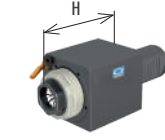

#### BARUFFALDI VDI - DIN69880



\* En caso de pedido, especifique siempre la orientación izquierda o derecha que necesita

d1	Ref.	ER	H	Nm	Rpm	PRECIO €	PRECIO ESPECIAL €
30	99.BF.0003	25	94	32	6000	<del>868</del>	<b>779</b>
	99.BF.0010	25	94	32	6000	<del>1.158</del>	<b>979</b>
40	99.BF.0005	32	117	63	5000	<del>1.047</del>	<b>929</b>
	99.BF.0011	32	115	63	5000	<del>1.350</del>	<b>1.179</b>

➡ Misma dirección de rotación que el husillo de la máquina

30	99.BF.0021	25	55	32	6000	<del>1.729</del>	<b>1.499</b>
	99.BF.0027	25	55	32	6000	<del>2.025</del>	<b>1.749</b>
40	99.BF.0024	32	100	63	5000	<del>2.077</del>	<b>1.749</b>
	99.BF.0030	32	100	63	5000	<del>2.433</del>	<b>2.049</b>

⬅ Dirección de rotación opuesta al husillo de la máquina

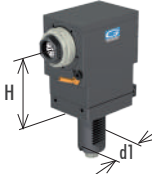

### DIN 1809

#### VDI - DIN69880



\* En caso de pedido, especifique siempre la orientación izquierda o derecha que necesita

d1	Ref.	ER	H	Nm	Rpm	PRECIO €	PRECIO ESPECIAL €
30	99.DP.0903	25	94	32	6000	<del>839</del>	<b>779</b>
	99.DP.0910	25	94	32	6000	<del>1.127</del>	<b>979</b>
40	99.DP.0905	32	115	63	5000	<del>1.010</del>	<b>879</b>
	99.DP.0911	32	115	63	5000	<del>1.307</del>	<b>1.129</b>

➡ Misma dirección de rotación que el husillo de la máquina

30	99.DP.0919	25	55	32	6000	<del>1.684</del>	<b>1.449</b>
	99.DP.0925	25	55	32	6000	<del>1.966</del>	<b>1.699</b>
40	99.DP.0922	32	100	63	5000	<del>2.017</del>	<b>1.699</b>
	99.DP.0928	32	100	63	5000	<del>2.359</del>	<b>1.999</b>

⬅ Dirección de rotación opuesta al husillo de la máquina

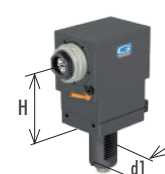
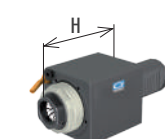

#### NUEVA GAMA BMT 55 FUERA DE CATÁLOGO CUERPO MACIZO NIQUELADO



d1	Ref.	Biglia Ref.	ER	H	Nm	Rpm	PRECIO ESPECIAL €
55	99.BG.A01	10.57.88.00	25	70	47	6.000	<b>699</b>
	99.BG.A02	T.134-00061	32	70	47	6.000	<b>699</b>
55	99.BG.A03	T.134-00071	32	70	47	6.000	<b>949</b>

➡ Misma dirección de rotación que el husillo de la máquina

d1	Ref.	Biglia Ref.	ER	H	Nm	Rpm	PRECIO ESPECIAL €
55	99.BG.A05	10.57.87.00	25	70	47	6.000	<b>1.249</b>
	99.BG.A06	T.134-00062	32	70	47	6.000	<b>1.249</b>
55	99.BG.A07	T.134-00072	32	70	47	6.000	<b>1.649</b>
	99.BG.A08	T.134-00076	25	100	47	6.000	<b>1.399</b>
55	99.BG.A09	T.134-00077	32	100	47	6.000	<b>1.399</b>
	99.BG.A10	T.134-00088	32	100	47	6.000	<b>1.649</b>

➡ Misma dirección de rotación que el husillo de la máquina

d1	Ref.	Biglia Ref.	ER	H	Nm	Rpm	SPECIAL PRICE €
55	99.BG.A15	T.134-00025	16	60	16	6.000	<b>2.849</b>
	99.BG.A16	T.134-00057	20	60	16	6.000	<b>2.849</b>

➡ Misma dirección de rotación que el husillo de la máquina

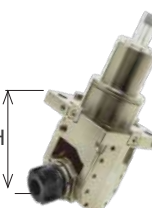
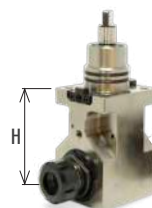
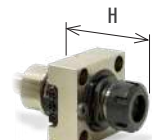

#### DMG MORI

#### NLX 1500-2000-2500-3000 12 Posiciones

#### NZX 12 Posiciones



Ref.	ER	H	Nm	Rpm	PRECIO €	PRECIO ESPECIAL €
99.MS.A59	32	86,2 ÷ 89,9	60	10.000	<del>1.212</del>	<b>999</b>
99.MS.A60	32	86,2 ÷ 89,9	60	10.000	<del>1.793</del>	<b>1.429</b>
99.MS.A62	40	88,5 ÷ 92	60	10.000	<del>1.212</del>	<b>999</b>
99.MS.A63	40	88,3 ÷ 92	60	10.000	<del>1.793</del>	<b>1.429</b>

99.MS.A72	32	Max 90	60	10.000	<del>2.596</del>	<b>2.099</b>
99.MS.A73	32	Max 90	60	10.000	<del>2.985</del>	<b>2.349</b>
99.MS.A76	40	90	60	10.000	<del>2.596</del>	<b>2.099</b>
99.MS.A77	40	90	60	10.000	<del>2.985</del>	<b>2.349</b>

➡ ⬅ Ambas direcciones de rotación del husillo disponibles\*

#### NZ 1500-2000-3100-

#### 3150-3200 16 Posiciones



Ref.	ER	H	Nm	Rpm	PRECIO €	PRECIO ESPECIAL €
99.MS.A101	25	80,6 ÷ 84,3	50	12.000	<del>1.212</del>	<b>1.049</b>
99.MS.A102	25	80,6 ÷ 84,3	50	12.000	<del>1.793</del>	<b>1.479</b>
99.MS.A103	32	85,5 ÷ 89,2	50	12.000	<del>1.212</del>	<b>1.049</b>
99.MS.A104	32	85,5 ÷ 89,2	50	12.000	<del>1.793</del>	<b>1.479</b>

➡ Misma dirección de rotación que el husillo de la máquina

99.MS.A106	25	85	50	12.000	<del>2.596</del>	<b>2.099</b>
99.MS.A107	25	85	50	12.000	<del>2.985</del>	<b>2.349</b>
99.MS.A108	32	85	50	12.000	<del>2.596</del>	<b>2.099</b>
99.MS.A109	32	85	50	12.000	<del>2.985</del>	<b>2.349</b>

⬅ Dirección de rotación opuesta al husillo de la máquina



Válido hasta el 31 de Diciembre 2023

## HERRAMIENTAS MOTORIZADAS PARA TORNOS CNC - ¡MEJORE SU TORNO Y AUMENTE LA PRODUCTIVIDAD!

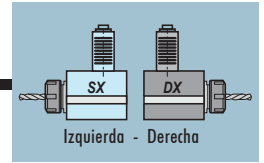

### VDI 40

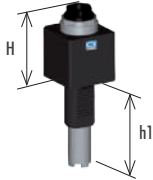

Ref.	ER	H	h1	Nm	Rpm	PRECIO €	PRECIO ESPECIAL €
99.HA.590082	32	75	117,5	63	6000	<del>917</del>	<b>749</b>
99.HA.590082B	32	75	117,5	63	6000	<del>1.144</del>	<b>899</b>
99.HA.590083	32	75	104,8	63	6000	<del>917</del>	<b>749</b>
99.HA.590083B	32	75	104,8	63	6000	<del>1.144</del>	<b>899</b>
99.HA.596352	32	75	130,25	63	6000	<del>917</del>	<b>749</b>
99.HA.596352B	32	75	130,25	63	6000	<del>1.144</del>	<b>899</b>

Misma dirección de rotación que el husillo de la máquina



\* Accionamiento intercambiable para los distintos tipos de torretas Haas

Ref.	ER	H	h1	Nm	Rpm	PRECIO €	PRECIO ESPECIAL €
99.HA.590084	32	75	117,5	63	6000	<del>1.721</del>	<b>1.349</b>
99.HA.590084B	32	75	117,5	63	6000	<del>2.174</del>	<b>1.699</b>
99.HA.590085	32	75	104,8	63	6000	<del>1.721</del>	<b>1.349</b>
99.HA.590085B	32	75	104,8	63	6000	<del>2.174</del>	<b>1.699</b>
99.HA.596353	32	75	130,25	63	6000	<del>1.721</del>	<b>1.349</b>
99.HA.596353B	32	75	130,25	63	6000	<del>2.174</del>	<b>1.699</b>

Misma dirección de rotación que el husillo de la máquina

## Mazak

### QTN2 12 Posiciones

QUICK TURN NEXUS QTN 200/250  
SUPER QUADREX TURN SQT 15/18 - 200/250



Ref.	ER	H	Nm	Rpm	PRECIO €	PRECIO ESPECIAL €
99.MZ.A58	32	116,2 ÷ 120	80	6000	<del>2.418</del>	<b>1.549</b>
99.MZ.A59	32	116,2 ÷ 120	80	6000	<del>2.922</del>	<b>2.100</b>



99.MZ.A65	32	130	80	6000	<del>2.619</del>	<b>1.649</b>
99.MZ.A66	32	130	80	6000	<del>2.821</del>	<b>1.949</b>

Dirección de rotación opuesta al husillo de la máquina

## Mazak

### SMART QTS1 - BMT68

QUICK TURN SMART QTS 100M / 200M  
QT COMPACT 100M - 200M - 300M

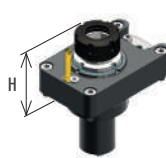

Ref.	ER	H	Nm	Rpm	PRECIO €	PRECIO ESPECIAL €
99.MZ.A03	32	Max 70	60	6000	<del>1.914</del>	<b>1.549</b>
99.MZ.A06	32	Max 70	60	6000	<del>2.317</del>	<b>1.949</b>

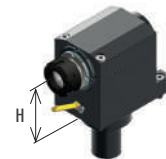

99.MZ.A09	32	80	60	6000	<del>2.619</del>	<b>2.099</b>
99.MZ.A10	32	80	60	6000	<del>2.821</del>	<b>2.399</b>

Dirección de rotación opuesta al husillo de la máquina

## Miyano

045: WT100 - TW1

054: WT100 - TW1



d1	Ref.	ER	H	Nm	Rpm	PRECIO €	PRECIO ESPECIAL €
45	99.MY.A02	25	53,9 ÷ 57,6	35	6000	<del>828</del>	<b>749</b>
	99.MY.A03	25	53,9 ÷ 57,6	35	6000	<del>992</del>	<b>899</b>
54	99.MY.A09	32	75,7 ÷ 79,4	60	6000	<del>964</del>	<b>849</b>
	99.MY.A10	32	75,7 ÷ 79,4	60	6000	<del>1.106</del>	<b>949</b>

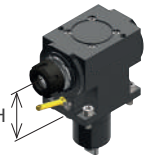

45	99.MY.A05	25	65	35	6000	<del>1.462</del>	<b>1.249</b>
	99.MY.A06	25	65	35	6000	<del>1.757</del>	<b>1.649</b>
54	99.MY.A11	32	75	60	6000	<del>1.813</del>	<b>1.549</b>
	99.MY.A12	32	75	60	6000	<del>2.142</del>	<b>1.849</b>

Dirección de rotación opuesta al husillo de la máquina



### BMT44 WT100 - TW1

BMT55 SUPER NTJ-NTJX / NTM 3 / TMC 18 /  
TW10 / SC150-250 / WT150-250 / WTW 150 /  
WTS 150 / WT100



d1	Ref.	ER	H	Nm	Rpm	PRECIO €	PRECIO ESPECIAL €
45	99.NK.A40	25	Max 57,2	40	6000	<del>918</del>	<b>799</b>
	99.NK.A43	25	Max 57,2	40	6000	<del>1.049</del>	<b>899</b>
55	99.NK.A03	32	68,5 ÷ 72,2	63	6000	<del>964</del>	<b>849</b>
	99.NK.A04	32	68,5 ÷ 72,2	63	6000	<del>1.485</del>	<b>1.299</b>



45	99.NK.A50	25	60	40	6000	<del>1.627</del>	<b>1.399</b>
	99.NK.A53	25	60	40	6000	<del>1.949</del>	<b>1.699</b>
55	99.NK.A13	32	55	63	6000	<del>1.813</del>	<b>1.549</b>
	99.NK.A14	32	55	63	6000	<del>2.445</del>	<b>2.099</b>

## LOKUMA

BMT60: SPACE TURN LB 200EX / LB 2500EX  
/ LB3000EX / GENOS SERIES L300-MW /  
MULTUS U3000 / U40007 / LU3000EX M / MY

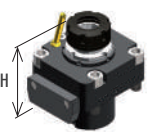

d1	Ref.	ER	H	Nm	Rpm	PRECIO €	PRECIO ESPECIAL €
60	99.OK.A80	32	Max 79	60	6000	<del>1.637</del>	<b>1.299</b>
	99.OK.A81	32	Max 79	60	6000	<del>2.078</del>	<b>1.599</b>



Misma dirección de rotación que el husillo de la máquina

60	99.OK.A82	32	70	60	6000	<del>2.959</del>	<b>2.299</b>
	99.OK.A83	32	70	60	6000	<del>3.525</del>	<b>2.749</b>

Dirección de rotación opuesta al husillo de la máquina



### BMT65: M06D / M06SD / M06SY / M08SD / M08SY

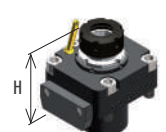

Ref.	ER	H	Nm	Rpm	PRECIO €	PRECIO ESPECIAL €
99.TS.A01	25	MAX 60	40	8000	<del>1.512</del>	<b>1.199</b>
99.TS.A02	25	MAX 60	40	8000	<del>2.078</del>	<b>1.649</b>

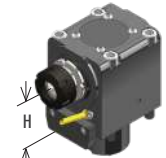

99.TS.A08	25	65	40	8000	<del>2.455</del>	<b>1.949</b>
99.TS.A09	25	65	40	8000	<del>3.021</del>	<b>2.449</b>



Válido hasta el 31 de Diciembre 2023

**NEW! ¡ AHORA TAMBIÉN LA LÍNEA CLÁSICA DE CABEZALES ANGULARES CON PRECIO ESPECIAL !**

### EQUIPAMIENTO ESTÁNDAR

Bolsa especial / Tope / Tuerca ER / Llaves / Tubo de grasa / Manual de instrucciones

Escanea el código QR y descubre más información



- Ratio 1:1
- Rpm 8.000
- N 510
- Nm 24

- Kg 5,4
- Ø 16
- M 12
- ER25 Ø1/16

### EQUIPAMIENTO ESTÁNDAR

Bolsa especial / Tope / Tuerca ER / Llaves / Tubo de grasa / Manual de instrucciones

Escanea el código QR y descubre más información



- Ratio 1:1
- Rpm 4.000
- N 1.250
- Nm 40

- Kg 11
- Ø 20
- M 16
- ER32 Ø2/20

### LÍNEA CLÁSICA ATC

**G90-16**

PRECIO ~~€ 3.598~~  
PRECIO ESPECIAL **3.000**

### LÍNEA CLÁSICA ATC

**G90-20**

PRECIO ~~€ 3.804~~  
PRECIO ESPECIAL **3.200**

**AMPLIA GAMA DE CABEZALES ANGULARES**

casi 200 tipos de cabezales angulares clásicos disponibles

**MÁXIMA RIGIDEZ**

gracias al vástago integral y al eje fabricados en una sola pieza

**CUERPO AJUSTABLE 360°**

Máxima rigidez y resistente a la corrosión. Expansión térmica mínima

**TUERCAS DE RODAMIENTO DE BOLAS ABEC 9**

Rodamientos de contacto angular precargados con lubricación con grasa de larga duración.

**ENGRANAJES GLEASON**

Garantiza menos calentamiento y ruido y las Rpm más altas.



**3 en 1**  
AUTOCENTRANTE  
INDIVIDUAL  
DOBLE



MORDAZA AUTOCENTRANTE

**MAXI GRIP**

**AUTOCENTRADO, DOBLE O SIMPLE SUJECCIÓN.  
¡MÁXIMA ESTABILIDAD DE SUJECCIÓN Y VERSATILIDAD DE USO!**

**MÁXIMA COMPATIBILIDAD**

con el Punto Cero y con los sistemas de cambio de palets más populares

**PLACAS GRIP**

perfectas para sujetar cualquier tipo de material

**DOBLE SUJECCIÓN**

sujección simultánea de dos piezas de trabajo

**WOOW**

DESCUENTO HASTA EL **20%**

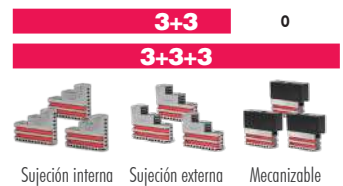

PLATOS AUTOCENTRANTES DOBLE GUÍA

**DUODUX**

**PRECISIÓN, RIGIDEZ Y ESTABILIDAD  
TAMBIÉN DURANTE EL MECANIZADO DE ALTO RENDIMIENTO**

**MODELOS ESPECIALES**

no sólo para medidas estándar

**MORDAZAS INTEGRALES**

para la mayor precisión y repetibilidad.

**DOBLE GUÍA**

puede soportar una mayor carga de trabajo y otorgar una mayor estabilidad